

MILITARY SPECIFICATION

CV 7594-5

SEMICONDUCTOR DEVICE, TRANSISTOR

Description:- This specification covers the detail requirements for Silicon PNP Planar Epitaxial High Speed Switching and R.F. Amplifying transistors and is in accordance with K1007, Issue 3, unless otherwise stated.

Mechanical Dimensions and Outlines:- K1007, Section B, 10.3.2.4. and 10.4.2.4.

Connections:- 1. Emitter - 2. Base - 3. Collector and Case.

Absolute Maximum Ratings:-

Rating	V _{CBO}		V _{CEO}		V _{EBO}	I _C	P _{tot}	P _{tot}	T _{stg}	T _{amb}	Shock	Vibration
	CV7594	CV7595	CV7594	CV7595								
Unit	V	V	V	V	V	mA	mW	mW	°C	°C	g	g
Min.	-	-	-	-	-	-	-	-	-65	-65	-	-
Max.	12	20	12	20	4	200	360	1200	200	200	1500	20
Note							A, B	B, C				D

- Notes:-
- A. At T_{amb} = 25°C.
 - B. See derating curve on Page 14
 - C. At T_{case} = 25°C.
 - D. Duration = 0.5 mS.
 - E. Commercial equivalents.

CV7594 - 2N2894.

CV7595 - 2N3209.

CV7594-5

Primary Electrical Characteristics

Characteristic	I_{CES}	I_{CES}	V_{CE}	V_{CE} (sat.)	V_{BE} (sat.)	h_{FE}				r_T	C_{ob}	C_{TE}	t_{ON}	t_{OFF}
Unit	mA	mA	V	V	V	40	30	25	17	Mc/s	pF	pF	ns	ns
CV7594	Min.		-12		-0.78	40	30	25	17	400				
	Max.	80	-10	-0.15	-0.98	150					5.0	6.0	60	90
CV7595	Min.		-20		-0.78	30	25	15	12	400				
	Max.	80	-10	-0.15	-0.98	120					5.0	6.0	60	90
Conditions	V_{CB}													
	V_{CE}	-6												
		-10					-0.5	-0.3	-1.0	-0.5	-10			
	V_{BE}	0	0									-0.5		
	I_C			10	30	100	30	10	100	30	30	0	30	30
	I_E										0			
	I_B			1.0	3.0	10	3.0	10						
	I_{B1}												1.5	1.5
	I_{B2}													1.5
	f											1.0	1.0	
T_{amb}	25	125	25	25	25	25	25	25	25	25	25	25	25	25

REQUIREMENTS:-

Marking: K1007, Section B, 1.3.4.

QUALITY ASSURANCE PROVISIONS:-

Destructive Tests. The tests listed in Table II, Group B Inspection, Sub-groups 2, 3 and 4 and in Table III, Group C Inspection, Sub-group 2 are considered destructive.

Group C Inspection. Inspection shall be conducted on the initial lot and thereafter every ninety days or every fifth lot whichever occurs first.

PREPARATION FOR DELIVERY:-

Packaging. The device shall be packed according to K1007, Section A, 1.2(c).

NATO STOCK NUMBERS:-

CV7594 - 5960-99-037-3954
CV7595 - 5960-99-037-3955

This specification has been prepared by and the Qualification Approval Authority is:-

Admiralty Surface Weapons Establishment,
Portsmouth, Hants,
England.

GROUP A INSPECTION

Table I

Examination or Test	Test Conditions		AQL %	Insp. Level	Symbol	Limits		Units
	K1007/ NATO Ref.	Specific Conditions				Min.	Max.	
<u>SUB-GROUP 1</u> Visual and Mechanical Inspection	5.1.1.		0.65	I				
<u>SUB-GROUP 2</u> Collector-emitter Cut-off Current, Emitter-base Short-circuited	7.2.5.4.	$V_{CE} = -6V$ for CV7594 $-10V$ for CV7595 $V_{BE} = 0$	1.0	II	I_{CES}	80		nA
Collector-base Breakdown Voltage, Emitter-base Open-circuit	7.2.1.	$I_C = 10 \mu A$ $I_E = 0$ CV7594 CV7595			V_{CBO}	12 20		V
Collector-emitter Sustaining Voltage	7.2.2.2.	Pulse Test $I_B = 0$ $I_C = 10 \text{ mA}$ Pulse Duration = $300 \mu s$ Duty Cycle = 1% CV7594 CV7595			V_{CEO} (sust.)	12 20		V

GROUP A INSPECTION

Table I

Examination or Test	K1007/ NATO Ref.	Test Conditions		Insp. Level	Symbol	Limits		Units
		Specific Conditions	AQL %			Min.	Max.	
Emitter-base Breakdown Voltage	7.2.3.	$I_C = 0$			V_{EBO}	4		V
		$I_E = 100 \mu A$						
Collector-emitter Saturation Voltage (1)	7.3.3.	$I_C = 30 \text{ mA}$			V_{CE} (sat.)		0.2	V
		$I_B = 3 \text{ mA}$						
Base-emitter Saturation Voltage (1)	7.3.1.	$I_C = 30 \text{ mA}$			V_{BE} (sat.)	0.85	1.2	V
		$I_B = 3 \text{ mA}$						
Static Forward Current Transfer Ratio (1)	7.3.4.2.	Pulse Test			h_{FE}			
		$I_C = 30 \text{ mA}$						
		$V_{CE} = -0.5V$						
		Pulse Duration = 300 μs						
		Duty Cycle = 1%						
		CV7594				40	150	
		CV7595				30	120	

GROUP A INSPECTION

Table I

Examination OR Test	Test Conditions		AQL %	Insp. Level	Symbol	Limits		Units
	K1007/ NATO Ref.	Specific Conditions				Min.	Max.	
<u>SUB-GROUP 3</u> Static Forward Current Transfer Ratio (2)	7.3.4.2.	Pulse Test $I_C = 10 \text{ mA}$ $V_{CE} = -0.3V$ Pulse Duration = $300 \mu\text{s}$ Duty Cycle = 1% CV7594 CV7595	2.5	I	h_{FE}	30 25		
Static Forward Current Transfer Ratio (3)	7.3.4.2.	Pulse Test $I_C = 100 \text{ mA}$ $V_{CE} = -1.0V$ Pulse Duration = $300 \mu\text{s}$ Duty Cycle = 1% CV7594 CV7595			h_{FE}	25 15		
Common Emitter Forward Current Transfer Ratio at High Frequency	7.5.2.	$I_C = 30 \text{ mA}$ $V_{CE} = -10V$ $f = 100 \text{ Mc/s}$			$ h_{fe} $	4		

GROUP A INSPECTION

Table I

Examination or Test	K1007/ NATO Ref.	Test Conditions Specific Conditions	AQL %	Insp. Level	Symbol	Limits		Units
						Min.	Max.	
<u>SUB-GROUP 4</u>								
Collector-emitter Cut-off Current, Emitter-base Short-circuited	7.2.5.4.	$V_{CE} = -6V$ for CV7594 $-10V$ for CV7595 $V_{BE} = 0$ $T_{amb} = 125^{\circ}C \pm 3^{\circ}C$	6.5	IA	I_{CES}		10	μA
Collector-emitter Saturation Voltage (2)	7.3.3.	$I_C = 10$ mA $I_B = 1$ mA			V_{CE} (sat.)		0.15	V
Collector-emitter Saturation Voltage (3)	7.3.3.	$I_C = 100$ mA $I_B = 10$ mA			V_{CE} (sat.)		0.5	V
Base-emitter Saturation Voltage (2)	7.3.1.	$I_C = 10$ mA $I_B = 1$ mA			V_{BE} (sat.)	0.78	0.98	V
Base-emitter Saturation Voltage (3)	7.3.1.	$I_C = 100$ mA $I_B = 10$ mA			V_{BE} (sat.)		1.7	V

GROUP A INSPECTION

Table I

Examination or Test	K1007/ NATO Ref.	Test Conditions		AQL %	Insp. Level	Symbol	Limits		Units
		Specific Conditions	Min.				Max.		
Static Forward Current Transfer Ratio (4)	7.3.4.2.	Pulse Test	Pulse Duration = 300 nS Duty Cycle = 1%			h_{FE}	17		
		$I_C = 30 \text{ mA}$ $V_{CE} = -0.5V$ $T_{amb} = -55^\circ C$					12		
Output Capacitance	7.4.8.	$V_{CB} = -5.0V$				C_{ob}		5	pF
		$I_E = 0$ $f = 1 \text{ Mc/s}$							
Emitter Transition Capacitance		$V_{EB} = -0.5V$				C_{TE}		6	pF
		$I_C = 0$ $f = 1 \text{ Mc/s}$							

GROUP A INSPECTION

Table I

Examination or Test	K1007/ NATO Ref.	Test Conditions Specific Conditions	AQL %	Insp. Level	Symbol	Limits		Units
						Min.	Max.	
Turn-on Time		$I_C = 30 \text{ mA}$ $I_{B1} = 1.5 \text{ mA}$ See Fig. 2 on Page 15			t_{ON}		60	nS
Turn-off Time		$I_C = 30 \text{ mA}$ $I_{B1} = I_{B2} = 1.5 \text{ mA}$ See Fig. 2 on Page 15			t_{OFF}		90	nS

Table II

GROUP B INSPECTION

(See Page 3. Quality Assurance Provisions, Destructive Tests)

Examination or Test	Test Conditions		AQL %	Insp. Level	Symbol	Limits		Units
	K1007/ NATO Ref.	Specific Conditions				Min.	Max.	
<u>SUB-GROUP 1</u> Physical Dimensions	5.1.2.	According to Drawings 10.3.2.4. and 10.4.2.4.	6.5	IC				
<u>SUB-GROUP 2</u> Solderability	5.13.		4.0	IA				
Temperature Cycling	5.5.	-65°C to +200°C						
Moisture Resistance	5.3.							
<u>SUB-GROUP 3</u> Vibration Fatigue	5.15.	Non-operating	4.0	IA				
Constant Acceleration	5.14.	Non-operating. 20,000g						
<u>SUB-GROUP 4</u> Lead Fatigue	5.10.2.	1 Cycle	6.5	IA				
<u>SUB-GROUP 5</u> Omitted								
<u>SUB-GROUP 6</u> Omitted								

GROUP B INSPECTION

Table II

Examination or Test	Test Conditions		AQL %	Insp. Level	Symbol	Limits		Units
	K1007/ NATO Ref.	Specific Conditions				Min.	Max.	
<u>SUB-GROUP 7</u> High Temperature Life (Non-operating)	6.2.1.	$T_{amb} = 200^{\circ}C$	4.0	I				
	6.6.1.2.2.	$t = 1000$ hours						
<u>SUB-GROUP 8</u> Operating Life	6.3.	$V_{CB} = -6V$ min. for CV7594	4.0	IA				
	6.5.	$-10V$ min. for CV7595						
	6.6.1.1.	T_{amb} within the range $25^{\circ}C$ to $150^{\circ}C$						
	6.6.1.2.2.	$P_{tot} = \text{max. value given by the derating curve Fig. 1, Page 14 according to the chosen } T_{amb}$						
<u>Post Test End Points for Sub-groups 2, 3 and 7</u> Collector-emitter Cut-off Current, Emitter-base Short circuited	7.2, 5.4.	As in Group A, Sub-group 2			I_{CES}		160	nA

GROUP B INSPECTION

Table II

Examination or Test	K1007/ NATO Ref.	Test Conditions		AQL %	Insp. Level	Symbol	Limits		Units
		Specific Conditions					Min.	Max.	
Static Forward Current Transfer Ratio (1)	7.3.1.	As in Group A, Sub-group 2	CV7594 CV7595			h_{FE}	35 26	170 135	V
Collector-emitter Saturation Voltage (1)	7.3.3.	As in Group A, Sub-group 2				V_{CE} (sat.)	0.22		V
Base-emitter Saturation Voltage (1)	7.3.1.	As in Group A, Sub-group 2				V_{BE} (sat.)	1.32		V
<u>Post Test End Points for Sub-group 8</u>									
Collector-emitter Cut-off Current, Emitter-base Short-circuited	7.2.5.4.	As in Group A, Sub-group 2				I_{CES}	160		nA
Change of Static Forward Current Transfer Ratio (1)	7.3.1.	As in Group A, Sub-group 2				Δh_{FE}	± 15		%
Collector-emitter Saturation Voltage (1)	7.3.3.	As in Group A, Sub-group 2				V_{CE} (sat.)	0.22		V
Base-emitter Saturation Voltage (1)	7.3.1.	As in Group A, Sub-group 2				V_{BE} (sat.)	1.32		V

Table III

GROUP C INSPECTION

(See Page 3. Quality Assurance Provisions)

Examination or Test	K1007/ NATO Ref.	Test Conditions Specific Conditions	AQL %	Insp. Level	Symbol	Limits		Units
						Min.	Max.	
<u>SUB-GROUP 1</u>								
Omitted								
<u>SUB-GROUP 2</u>			6.5	IA				
Shock	5.17.	Non-operating. Five blows each orientation, Y ₁ , Y ₂ , X ₁ and Z ₁						
<u>Post Test End Points for Sub-group 2</u>								
Collector-emitter Cut-off Current, Emitter-base Short-circuit	7.2.5.4.	As in Group A, Sub-group 2			I _{CEs}	160		nA
Static Forward Current Transfer Ratio (1)	7.3.1.	As in Group A, Sub-group 2			h _{FE}			
		CV7594 CV7595				35 26		
Collector-emitter Saturation Voltage (1)	7.3.3.	As in Group A, Sub-group 2			V _{CE(sat.)}	0.22		V
Base-emitter Saturation Voltage (1)	7.3.1.	As in Group A, Sub-group 2			V _{BE(sat.)}	1.32		V

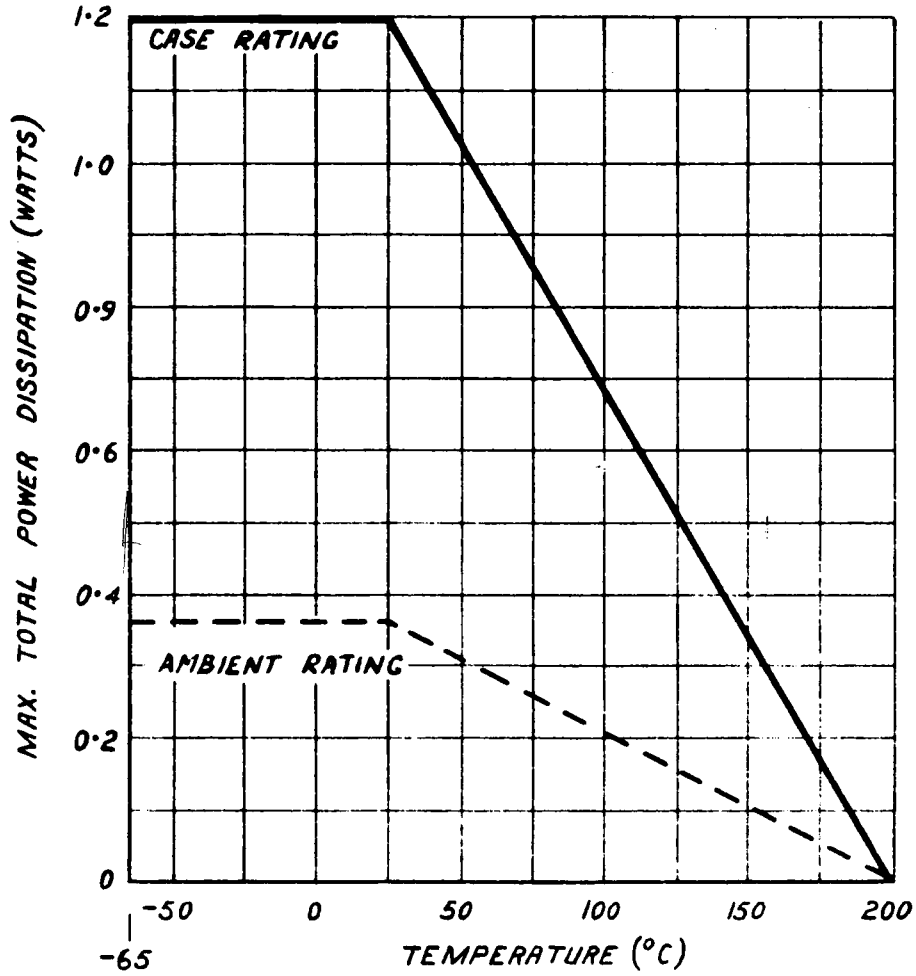
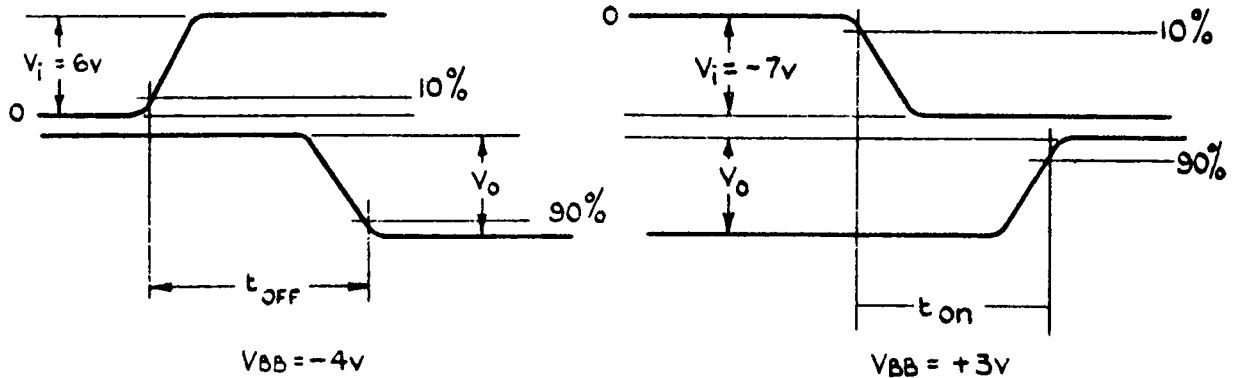

FIG. 1. DERATING CURVE

FIG. 2. t_{ON} AND t_{OFF} MEASUREMENT CIRCUIT



PULSE GENERATOR

$Z_g = 50$
 $t_r < 1ns$
 $t_w \gg 200ns.$
 DUTY CYCLE $< 2\%$

SAMPLING OSCILLOSCOPE

$Z_i = 100K\Omega$
 $t_r < 1ns.$

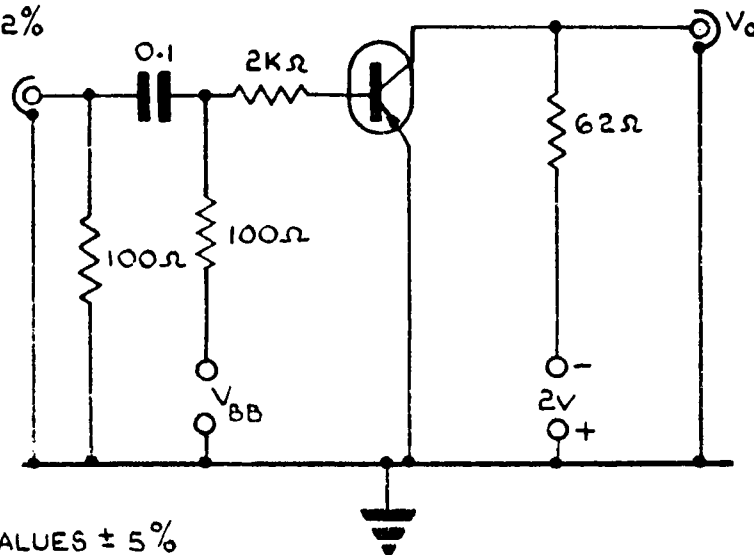

TYPICAL COLLECTOR CHARACTERISTICS

CV7594

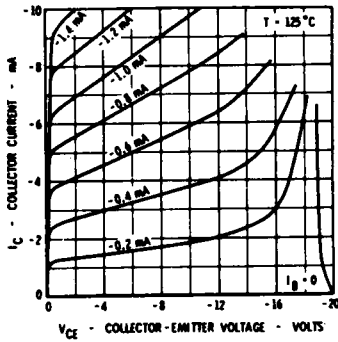

CV7595

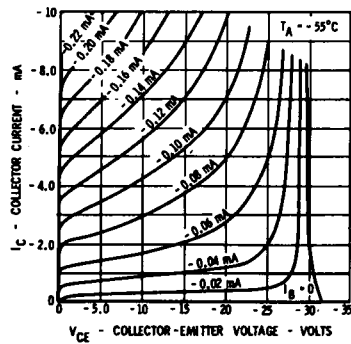
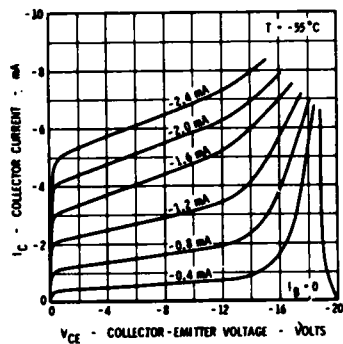
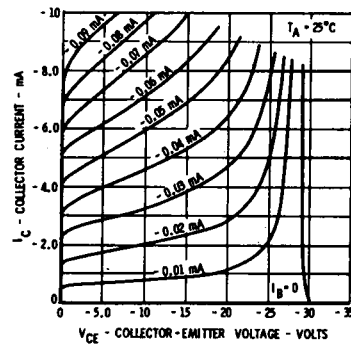
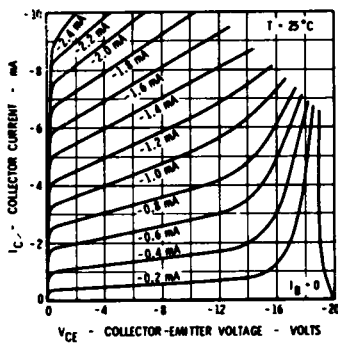
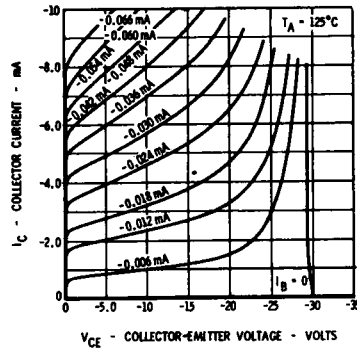

TYPICAL COLLECTOR AND BASE CHARACTERISTICS

SATURATION REGION

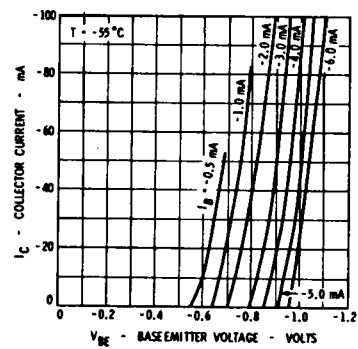
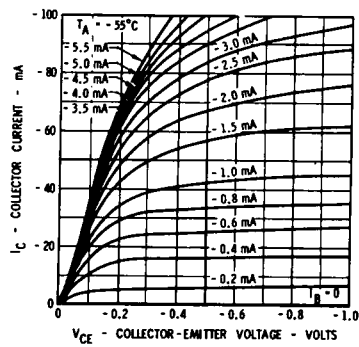
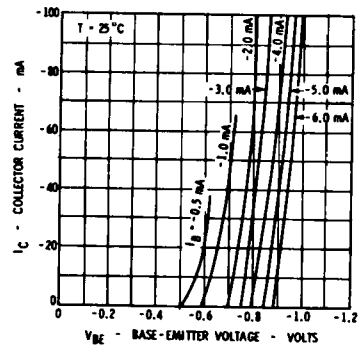
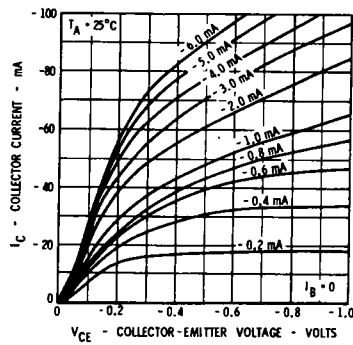
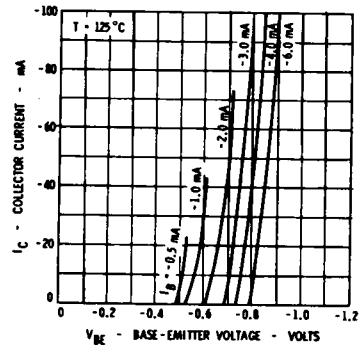
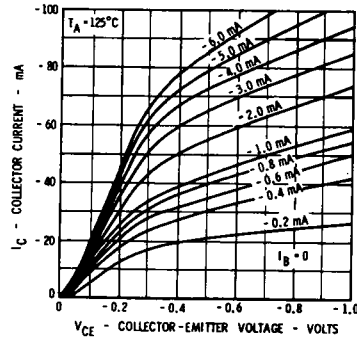

TYPICAL ELECTRICAL CHARACTERISTICS

CV7594

COLLECTOR-BASE REVERSE CURRENT VERSUS REVERSE BIAS VOLTAGE

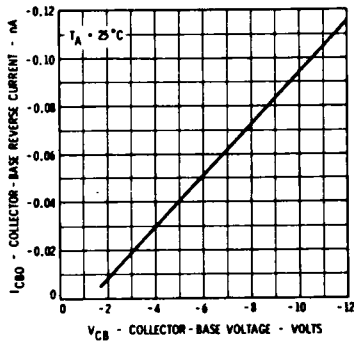

COLLECTOR-BASE DIODE REVERSE CURRENT VERSUS TEMPERATURE

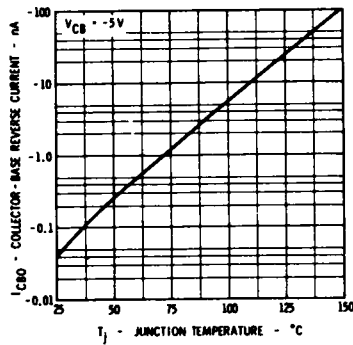

INPUT AND OUTPUT CAPACITANCES VERSUS REVERSE BIAS VOLTAGE

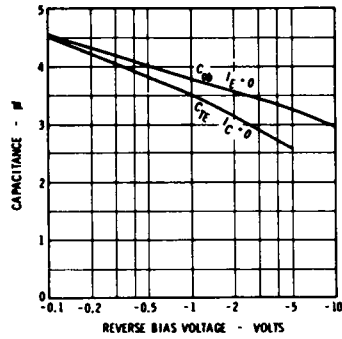

CV7595

COLLECTOR-BASE REVERSE CURRENT VERSUS REVERSE BIAS VOLTAGE

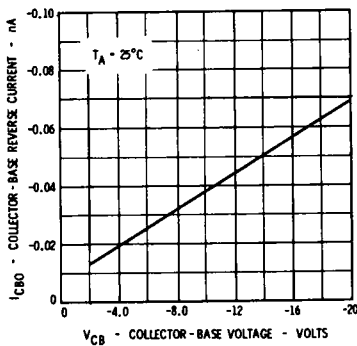

COLLECTOR-BASE DIODE REVERSE CURRENT VERSUS TEMPERATURE

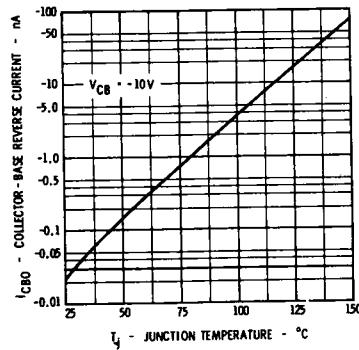

INPUT AND OUTPUT CAPACITANCES VERSUS REVERSE BIAS VOLTAGE

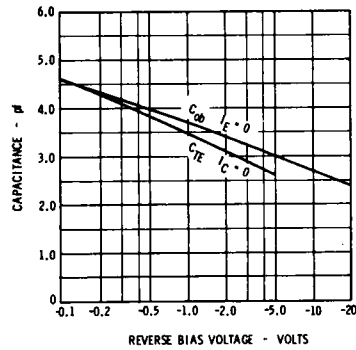

TYPICAL ELECTRICAL CHARACTERISTICS

PULSED DC CURRENT GAIN VERSUS COLLECTOR CURRENT

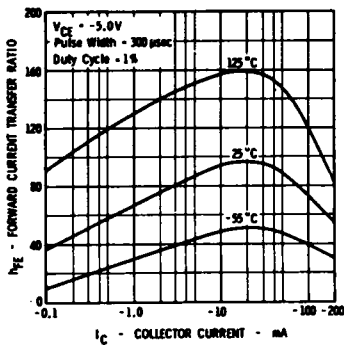

COLLECTOR SATURATION VOLTAGE VERSUS COLLECTOR CURRENT

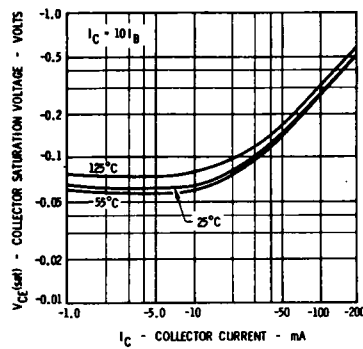

BASE SATURATION VOLTAGE VERSUS COLLECTOR CURRENT

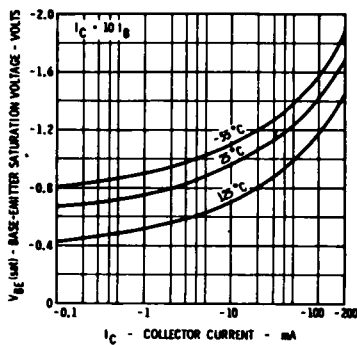

CONTOURS OF CONSTANT GAIN BANDWIDTH PRODUCT (f_T)

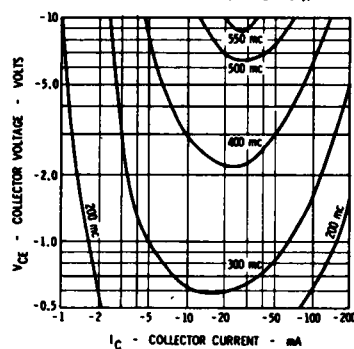

TYPICAL ELECTRICAL CHARACTERISTICS

DELAY TIME VERSUS TURN ON BASE CURRENT AND REVERSE BASE EMITTER VOLTAGE

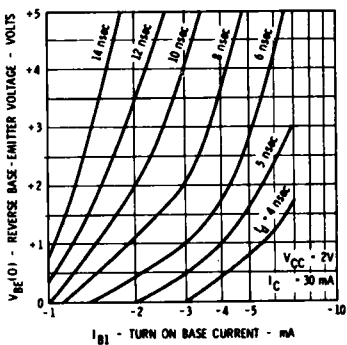

RISE TIME VERSUS COLLECTOR AND TURN ON BASE CURRENTS

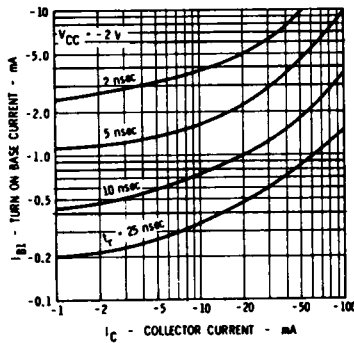

SWITCHING TIMES VERSUS COLLECTOR CURRENT

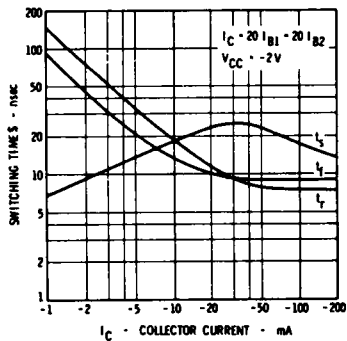

SWITCHING TIMES VERSUS TEMPERATURE

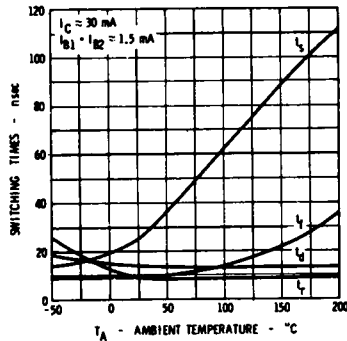

TYPICAL ELECTRICAL CHARACTERISTICS

STORAGE TIME VERSUS TURN ON AND TURN OFF BASE CURRENTS

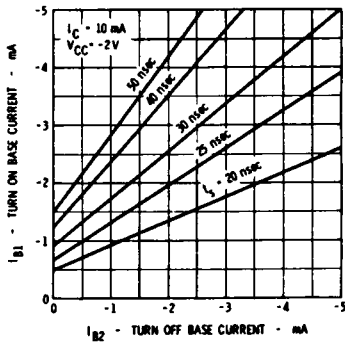

STORAGE TIME VERSUS TURN ON AND TURN OFF BASE CURRENTS

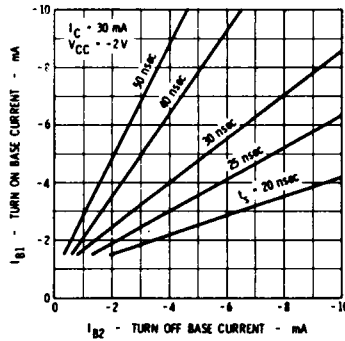

STORAGE TIME VERSUS TURN ON AND TURN OFF BASE CURRENTS

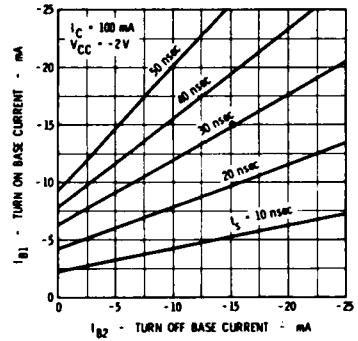

FALL TIME VERSUS TURN ON AND TURN OFF BASE CURRENTS

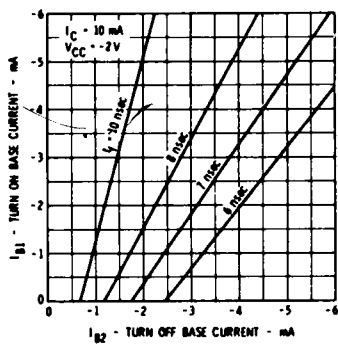

FALL TIME VERSUS TURN ON AND TURN OFF BASE CURRENTS

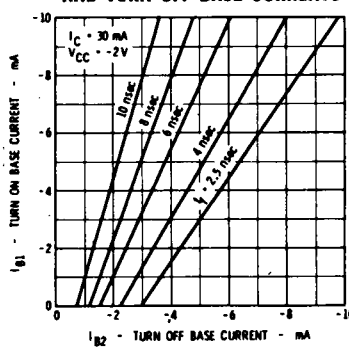

FALL TIME VERSUS TURN ON AND TURN OFF BASE CURRENTS

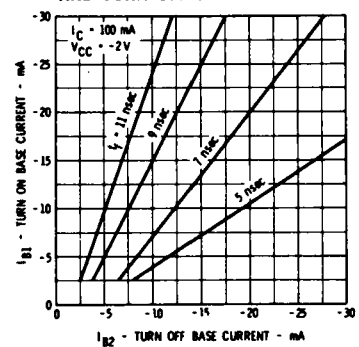

TYPICAL COMMON EMITTER "Y" PARAMETERS

INPUT ADMITTANCE VERSUS FREQUENCY-OUTPUT SHORT CIRCUIT

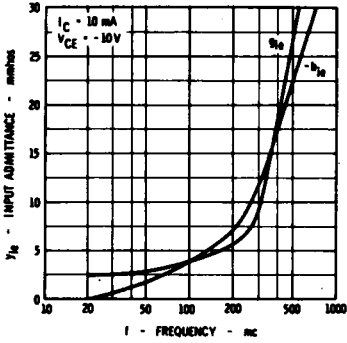

OUTPUT ADMITTANCE VERSUS FREQUENCY-INPUT SHORT CIRCUIT

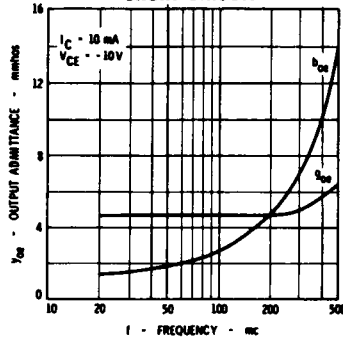

FORWARD TRANSFER ADMITTANCE VERSUS FREQUENCY-OUTPUT SHORT CIRCUIT

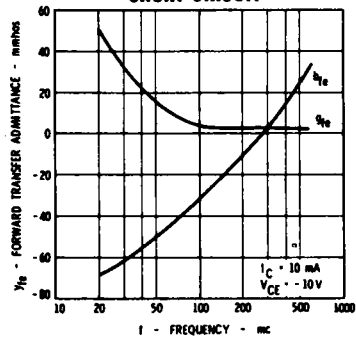

REVERSE TRANSFER ADMITTANCE VERSUS FREQUENCY-INPUT SHORT CIRCUIT

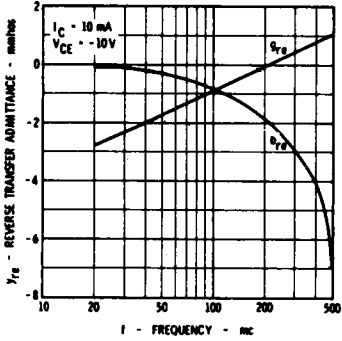

INPUT ADMITTANCE VERSUS COLLECTOR CURRENT AND VOLTAGE-OUTPUT SHORT CIRCUIT

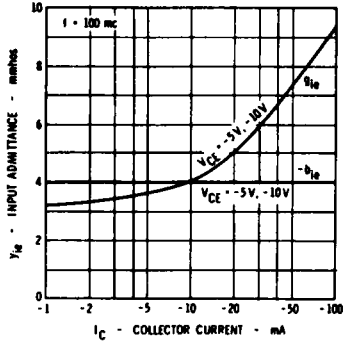

OUTPUT ADMITTANCE VERSUS COLLECTOR CURRENT AND VOLTAGE-INPUT SHORT CIRCUIT

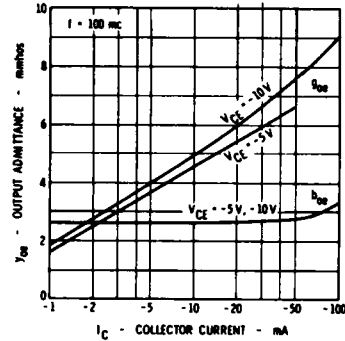

FORWARD TRANSFER ADMITTANCE VERSUS COLLECTOR CURRENT AND VOLTAGE-OUTPUT SHORT CIRCUIT

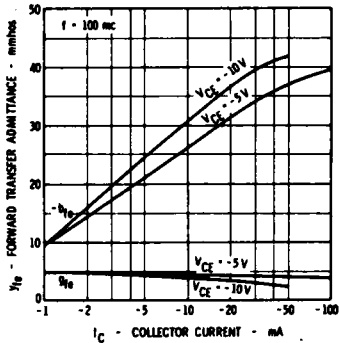

REVERSE TRANSFER ADMITTANCE VERSUS COLLECTOR CURRENT AND VOLTAGE-INPUT SHORT CIRCUIT

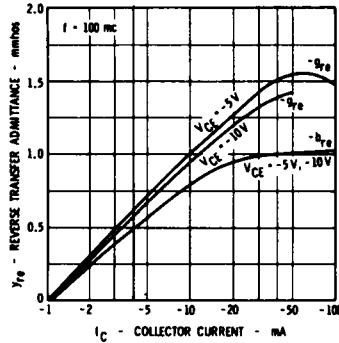

TYPICAL ELECTRICAL CHARACTERISTICS

NON SATURATED SWITCHING PERFORMANCE

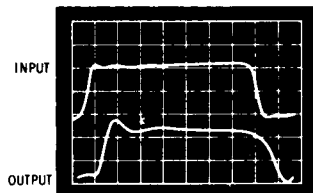
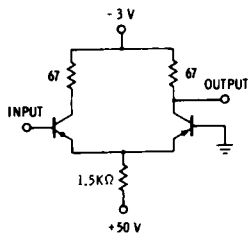

SCALE - 2 nsec/cm

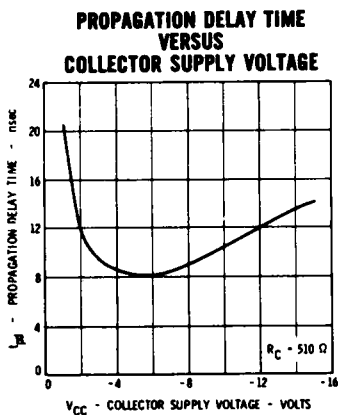
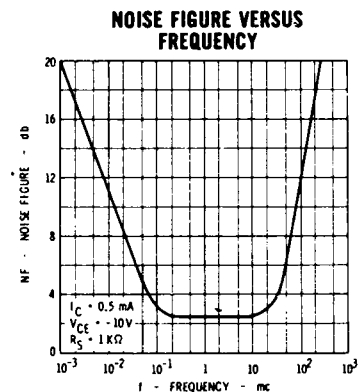
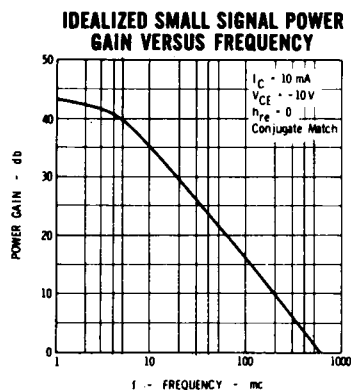
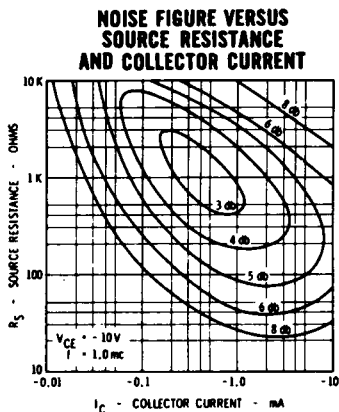

FIVE STAGE RING OSCILLATOR FOR MEASUREMENT OF PROPAGATION DELAY

